







CL.1 Deck-mounted basin spout without pop-up waste - Brushed Champagne (22kt Gold)

CL.1

13 717 705



- 200mm projection
- fixed spout
- rectangular spray pattern with 40 individual jets
- height of mixer 343 mm
- height up to aerator 329 mm
- hole diameter 35 mm
- max. flow 4 l/min
- 1/2" connection
- 2x screw-in M 10 x 1 pressure hose, leak-tested
- lead-free
- This product can help a building meet the requirements of Green Building Rating Systems, e.g. LEED®, BREEAM®, DGNB

	Brushed Champagne (22kt Gold)	13 717 705-46
	Chrome	13 717 705-00
	Brushed Platinum	13 717 705-06
	Dark Chrome	13 717 705-19
	Champagne (22kt Gold)	13 717 705-47
	Brushed Dark Platinum	13 717 705-99

13 717 705

mm [inches]

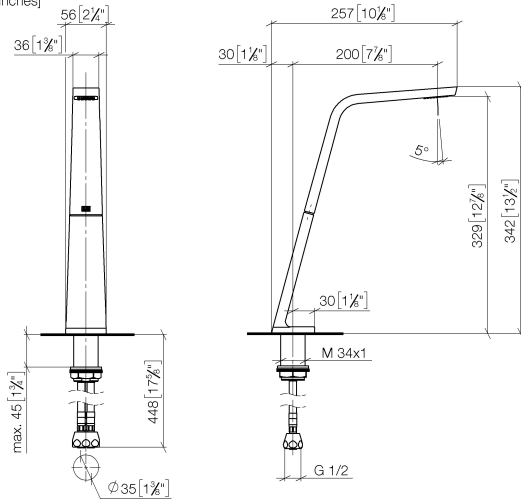

Flow rate chart

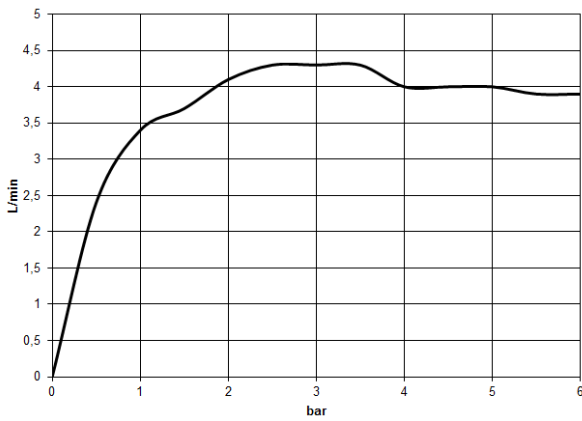

Codes & Standards

ASME
A112.18.1/CSA
B125.1

California Energy
Commission
(CEC)

NSF/ANSI 372

NSF/ANSI/CAN
61



CL.1 Deck-mounted basin spout without pop-up waste - Brushed Champagne
(22kt Gold)

CL.1

13 717 705

Certificates

GDV_0400279.

IAPMO_N-4976.

IAPMO_6397.

CL.1 Deck-mounted basin spout without pop-up waste - Brushed Champagne
(22kt Gold)

CL.1

13 717 705
Parts for other
finishes can be found
here: [Chrome](#)

